

280380
280380 6



FP 30



RC 2



SP

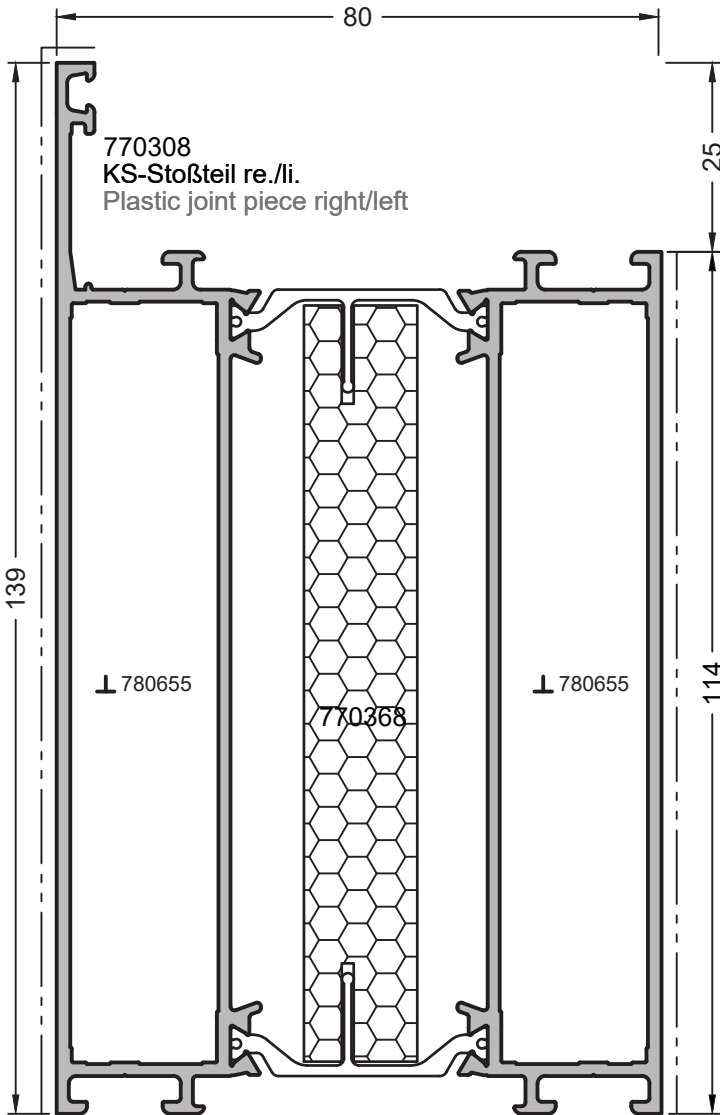

Sockelprofil 139/114 mm | Base profile 139/114 mm

280380
280380 6

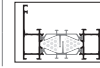

303423 313423 801236 801236

	280380	6000 mm	6000	6000	6000	6000
	280380 6	1450 mm				
		1	1	1	1	1
		497 mm	414	350	-	-
		253 mm	139	114	-	-

ix)
85,3 cm⁴

Zubehör | Accessories

	780655	780655
	885014	885014
	770308 ¹⁾	LI/RE
	770368	2000 mm 50

¹⁾ Alternativer Art. 778424 Alternative article 778424

280386
280386 6



FP 30



RC 2



SP

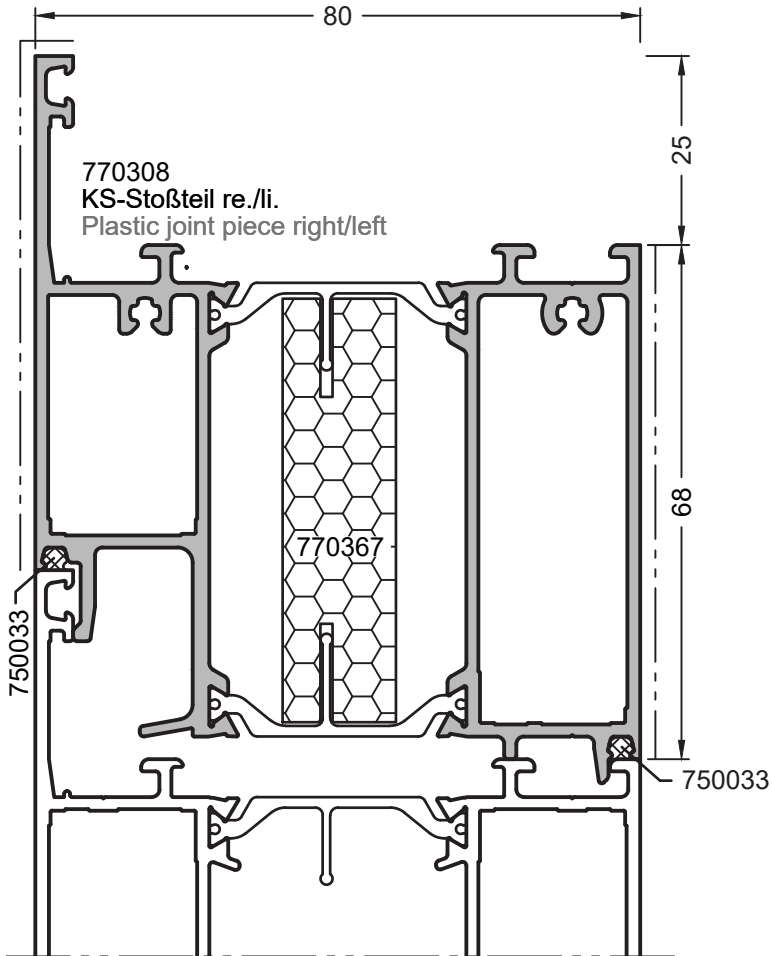

Sockelaufsatzprofil

68/68 mm

280386

280386 6



Base mounting profile

68/68 mm

303424

313424

801236

801236



280386 6000 mm
280386 6 1450 mm



	6000	6000	6000	6000
	1	1	1	1
	413 mm	330	245	-
	136 mm	68	68	-

↳

58,6 cm⁴

Zubehör | Accessories



780656 780656



770308¹⁾
LI/RE



780367 1000 mm 100

804009 1200 mm 2

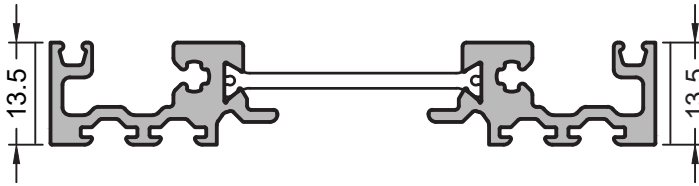
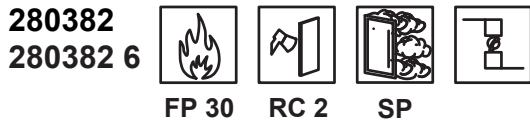

Sockelabschlußprofil | Base closure profile

280382					
280382 6					
		313426	313426	801237	
280382	6000 mm	6000	6000	6000	
280382 6	1450 mm				
	1	1	1	1	
	278 mm	157	157	-	
	27 mm	14	14	-	

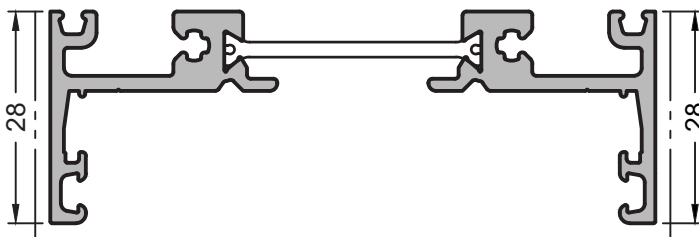

Sockelabschlußprofil | Base closure profile

280383					
280383 6					
		313425	313425	801237	
280383	6000 mm	6000	6000	6000	
280383 6	1450 mm				
	1	1	1	1	
	325 mm	180	180	-	
	56 mm	28	28	-	

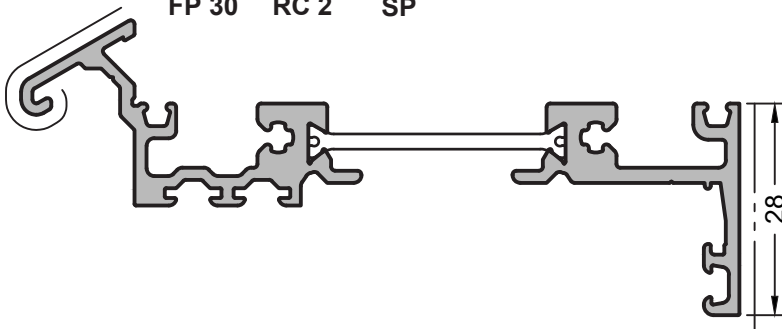
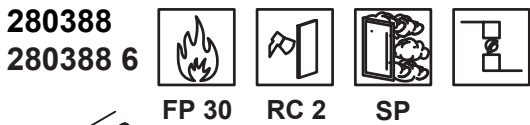

Sockelabschlußprofil | Base edging strip

280388					
280388 6					
		303425	313425	801237	
280388	6000 mm	6000	6000	6000	
280388 6	1450 mm				
	1	1	1	1	
	365 mm	220	180	-	
	54 mm	26	28	-	

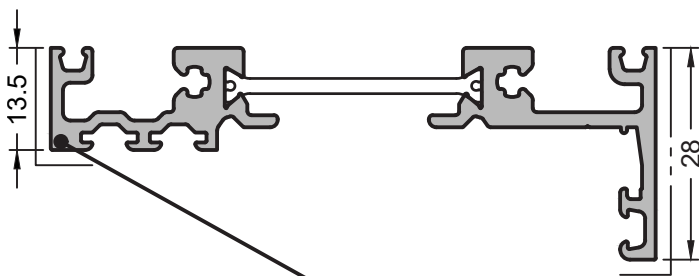
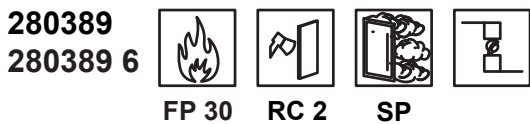

Sockelabschlußprofil | Base closure profile

280389					
280389 6					
		313426	313425	801237	
280389	6000 mm	6000	6000	6000	
280389 6	1450 mm				
	1	1	1	1	
	301 mm	157	180	-	
	42 mm	14	28	-	

Bei nach aussen öffnenden Türen die Profile spiegelbildlich montieren.

If the doors open outwards, profiles must be mounted as a mirror image.

280390 01
280390 601



FP 30 RC 2

Bei nach aussen öffnenden
Türen die Profile
spiegelbildlich montieren.
If the doors open outwards,
profiles must be mounted as a
mirror image.

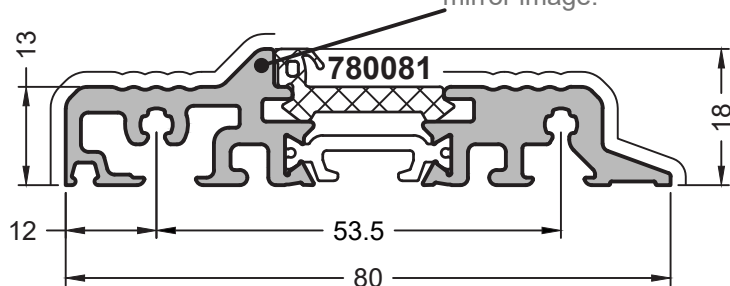

Schwellenprofil

E6/EV1 C0

280390 01
280390 601



Threshold profile

E6/EV1 C0

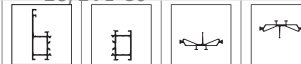

	6000 mm	303491	313491	801238
280390 01	6000 mm	6000	6000	6000
280390 601	1450 mm	6000	6000	6000
	1	1	1	1
		192	140	-
		39	38	-

280391 01
280391 601



FP 30 RC 2

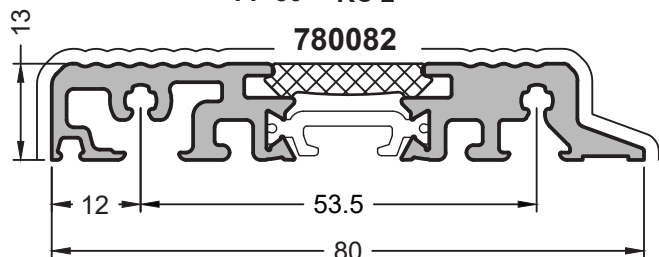

Schwellenprofil

E6/EV1 C0

280391 01
280391 601



Threshold profile

E6/EV1 C0

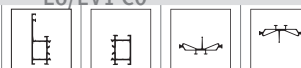

	6000 mm	303429	313491	801238
280391 01	6000 mm	6000	6000	6000
280391 601	1450 mm	6000	6000	6000
	1	1	1	1
		186	140	-
		42	38	-

460040
460040 6



FP 30 RC 2 SP

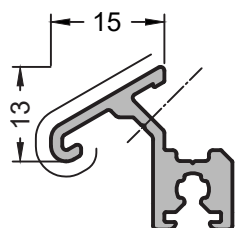

780301
Endkappe, siehe Kapitel Zubehör
End cap, see chapter accessories

460040
460040 6

Wetterschenkel | Drip rail

Lieferlänge Factory length	460040 460040 6	6000 mm 1450 mm		
Abwicklung Execution	eloxal anodized	123 mm	mech. mech.	26 mm

GLS 180	GWD 080	GWD 080i	GWD 070	GWD 070i	GWD 050n
	●				

460818
460818 6



FP 30



RC 2



SP

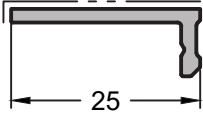

460818
460818 6

Zusatzschenkel | Additional leg

Lieferlänge Factory length	460818 460818 6	6000 mm 1450 mm
-------------------------------	----------------------------------	--------------------

Abwicklung Execution	eloxal anodized	66 mm	mech. mech.	27 mm
-------------------------	--------------------	-------	----------------	-------

GLS 180	GWD 080	GWD 080i	GWD 070	GWD 070i	GWD 050n
	●		●		